

**Картотека конструирования
из бумаги «Одежда»
(техника оригами)**

«Рубашка»

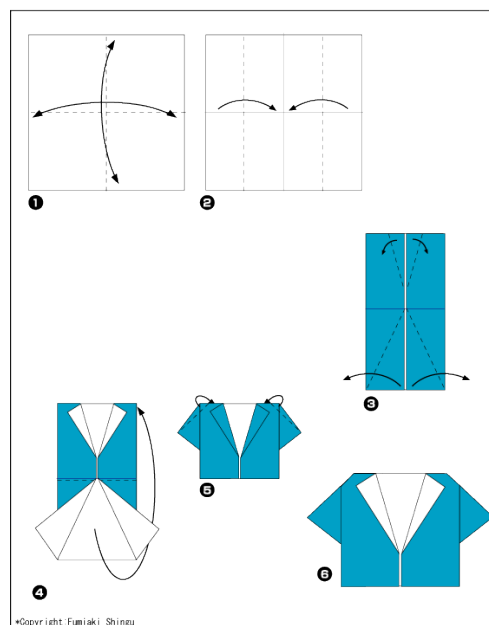

«Платье»

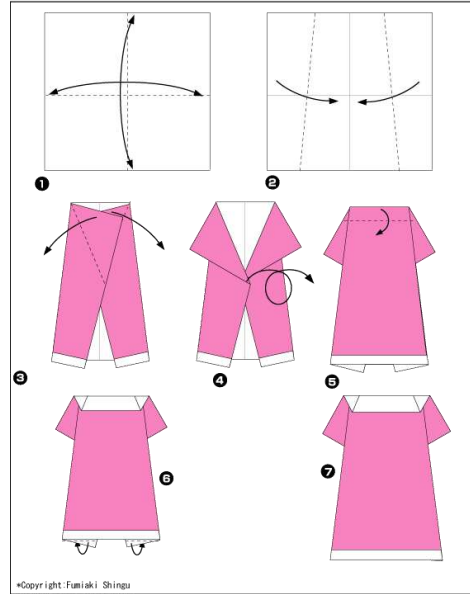

«Сарафан»

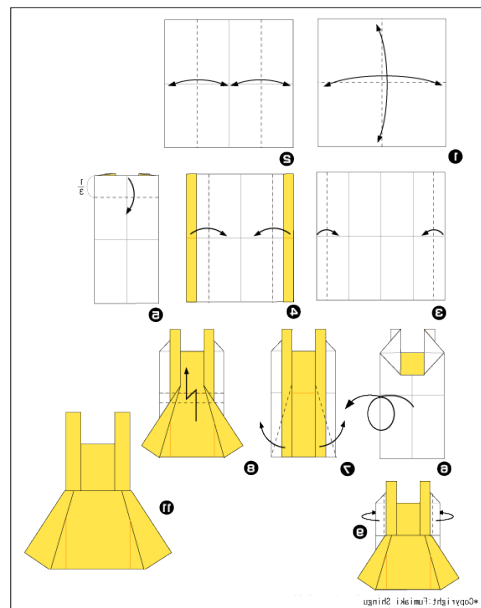

«Розовое платье»

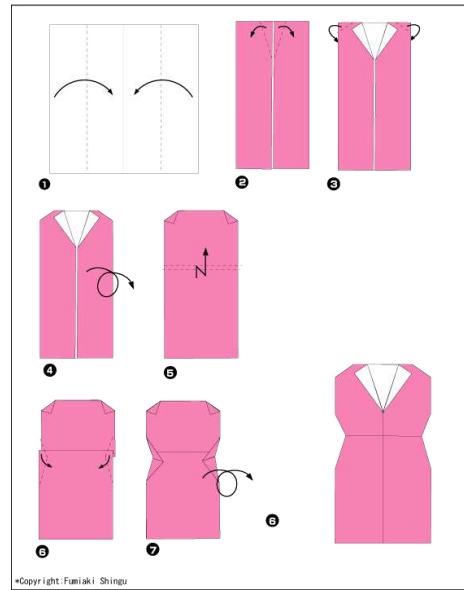

«Спортивный костюм»

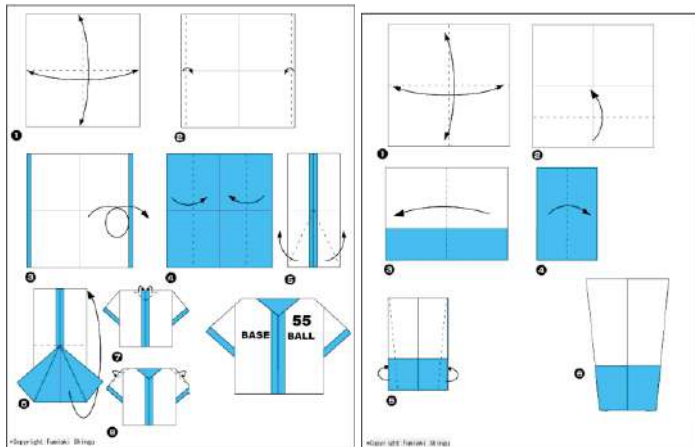

«Платье в горошек»

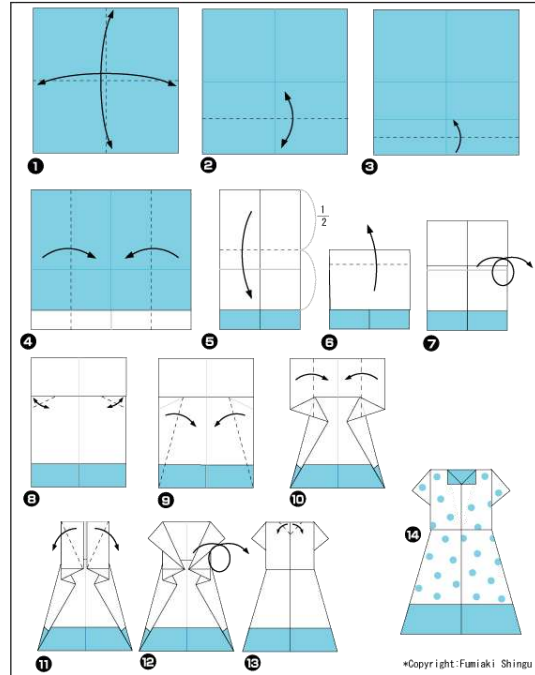

«Жилет и юбка»

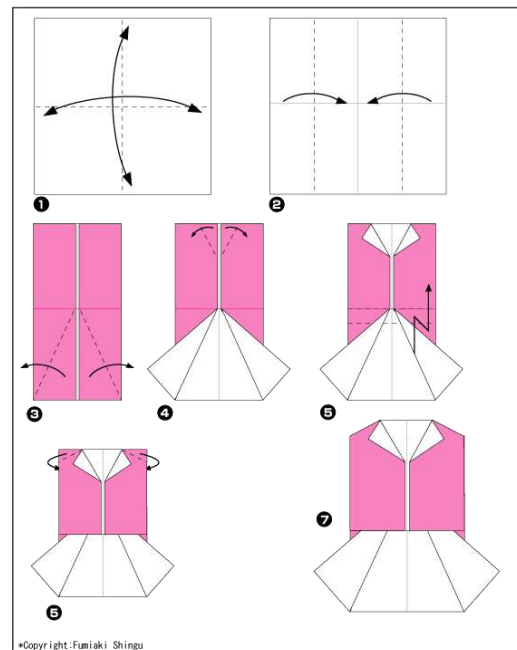

«Костюм»

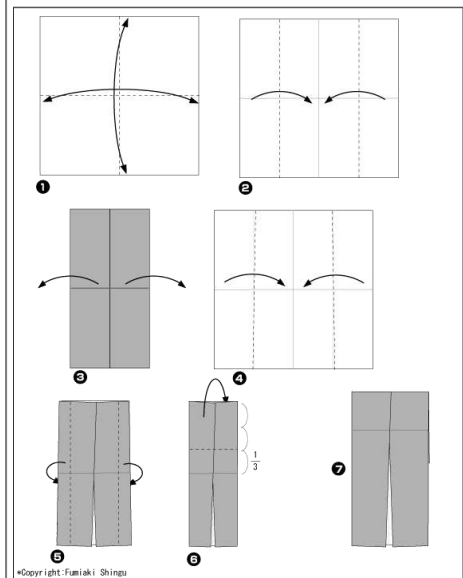
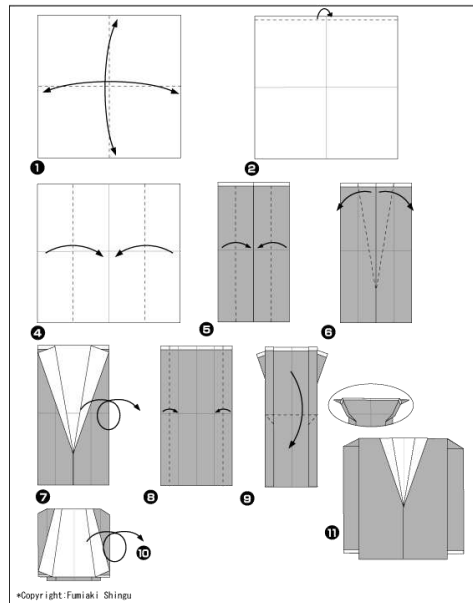

«Шорты»

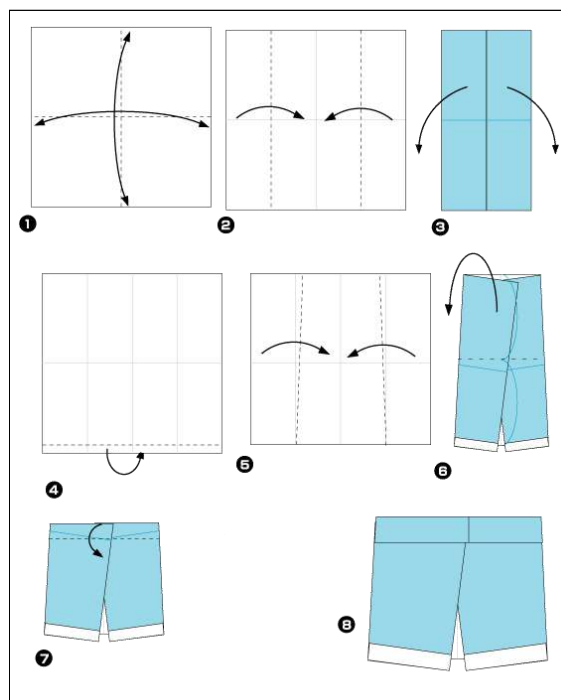

«Пальто»

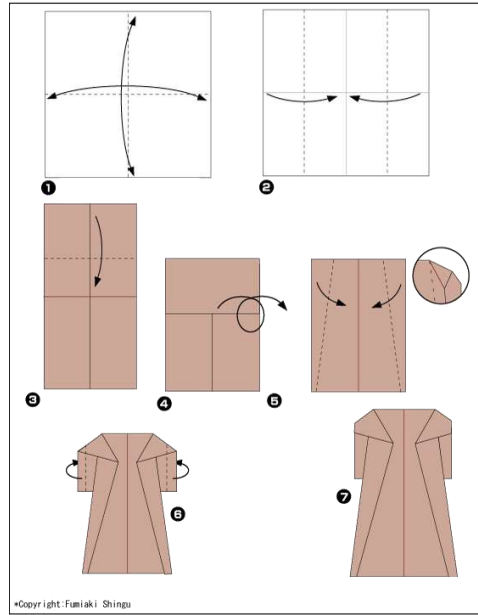

«Шапка самурая»

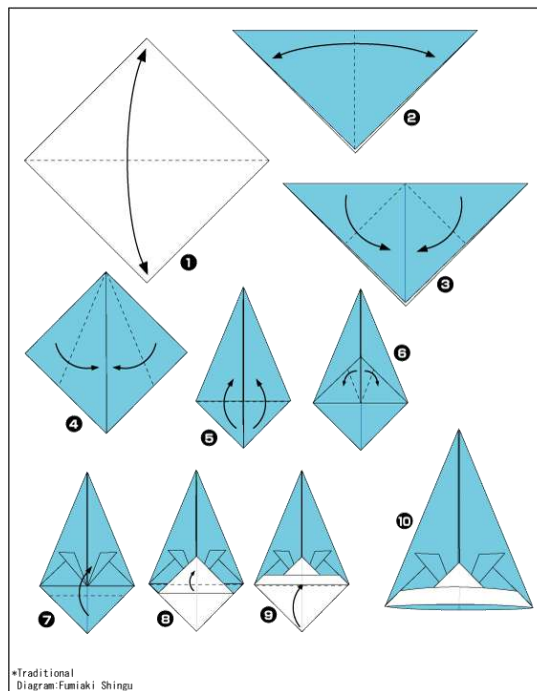

«Шапка»

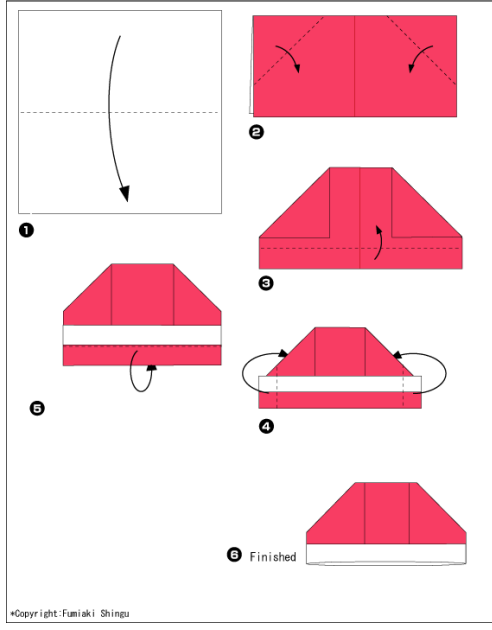

«Шапка из газеты»

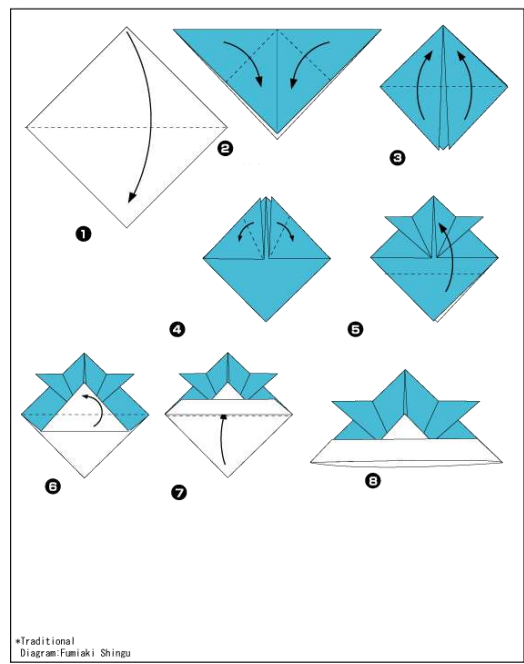

«Кепка из газеты»

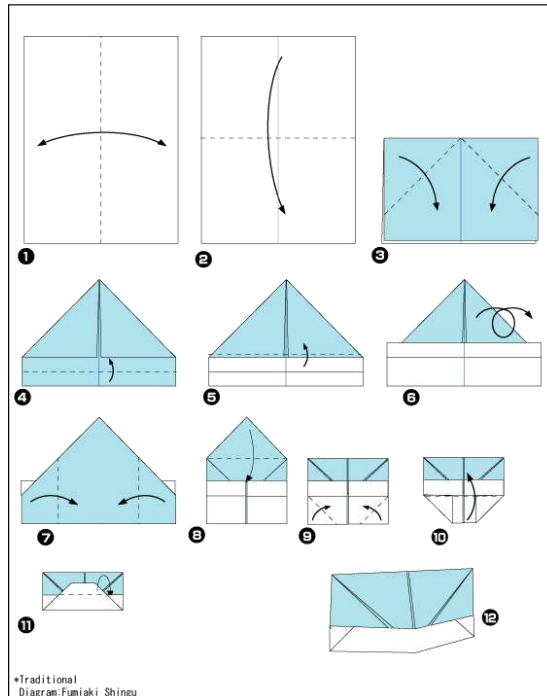

«Мексиканская шляпа из газеты»

